

Circle Chair

Design: Hans J. Wegner, 1986

pp130

ENQUIRIES
info@contextgallery.com

Tel. 404. 477. 3301
Tel. 800. 886. 0867

contextgallery.com



To the limits of the possible

The idea of making a chair based on the most simple and elegant shape of them all, the circle, remained a distant dream until Hans J. Wegner eventually completed the design at the age of 72. This bright sparkle, this tickling thought, matured over a lifetime and became one of his most visionary projects, posing great challenges for PP Møbler's workshop as its construction would push the limits of the possible.

Consequently the **Circle Chair** turned out to be one of Wegner's most characteristic designs and it still offers great comfort and flexibility. One of the many appealing features of the **Circle Chair** is the fact that despite the size and comfort it is light and transparent, very practical and easy to move around.

The **Circle Chair** definitely elevates Wegner into the exclusive league of artists who performed consistently at a very high level throughout a long life.



A circular thought

The **Circle Chair** was presented at the Cabinetmaker's Guild's Autumn Exhibition in 1986 and stands among the most successful and innovative design experiments conducted at PP Møbler.

Throughout most of his career Wegner was pursuing the basic idea of making an easy chair based on a ring. This notion resulted in a number of different chair designs that merely existed as sketches. At the age of 72, Wegner concluded over forty years of meditating on this simple thought by finishing the **Circle Chair**.

This was the last of the big visionary design projects of Wegner and the concept and complexity of the chair demanded the most accurately measured construction drawings and a highly innovative production set up.

Despite Wegner's bold and daring ambition, the **Circle Chair** is one of his most accommodating easy chairs capable of servicing all members of a family in comfort.

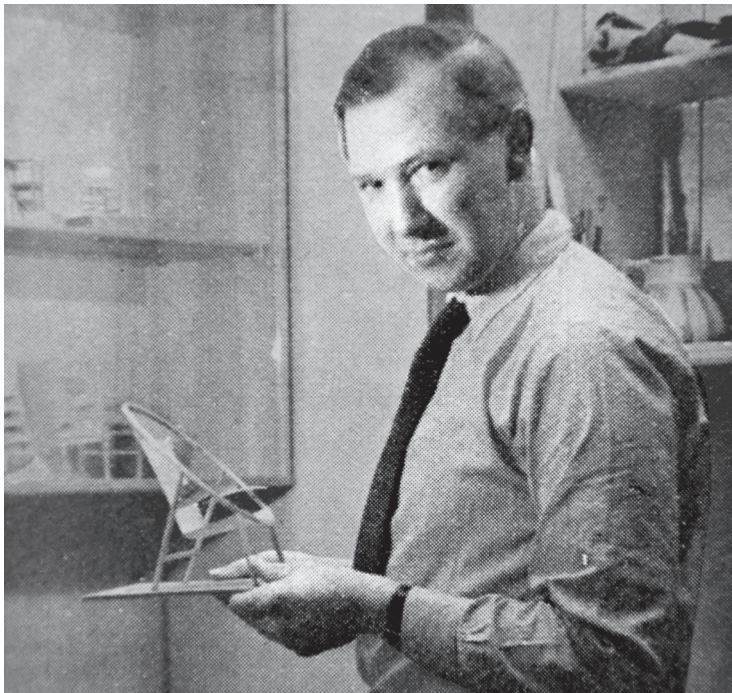

In 1950 Wegner made a scalemodel of an easy chair design based on an oval ring construction



Wegner presenting the prototype of the wooden **Circle Chair** to HRH Queen Ingrid of Denmark at the 1986 Cabinetmaker's Guild's Autumn Exhibition

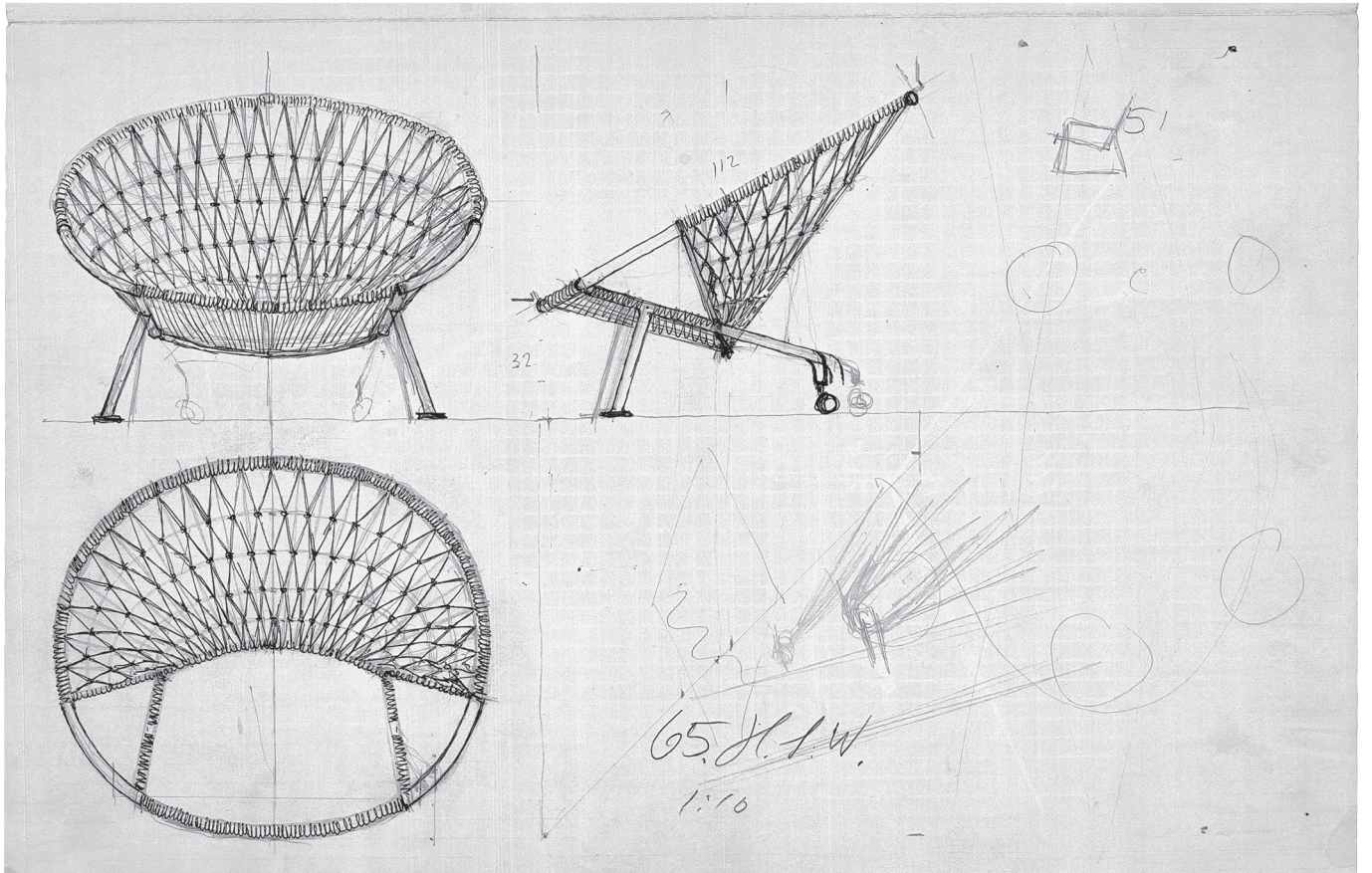
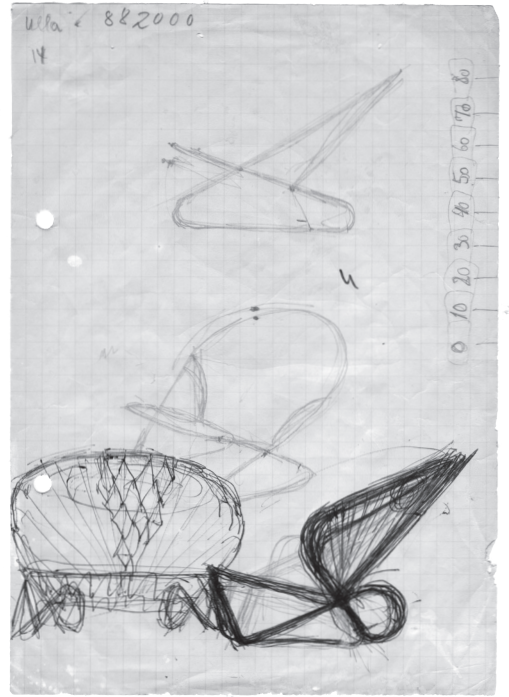
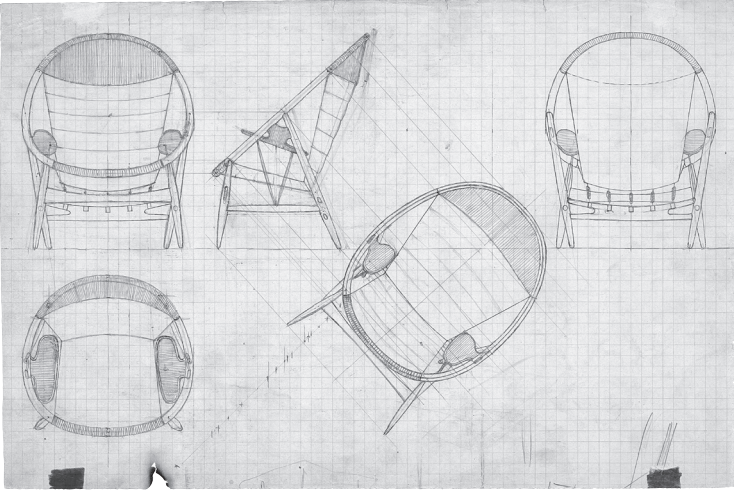

Wegner's first sketches bear a clear relationship to the **Peacock Chair** but later variations became more geometrical and made use of steel and flag line. The distinctive pattern created by clamping the flag line with metal clips appears on sketches drawn in early 1960 and the first drawings of the **Circle Chair** are dated 1965.

Wegner proposed making it in steel as he doubted that it would be possible to produce such a large ring in wood. In numerous experiments conducted in the workshop after normal working hours Wegner concluded that a steel construction was unworkable.

The flag line could not easily be held in place when wrapped around the metal ring while simply cutting slots to secure it to a wooden one would solve this problem.

One Sunday afternoon when Ejnar and his girlfriend Hanne Kjærholm entered the workshop to find Wegner frustrated by the obstacles to his steel experiments, the obvious question was, "Can this be made of wood?"

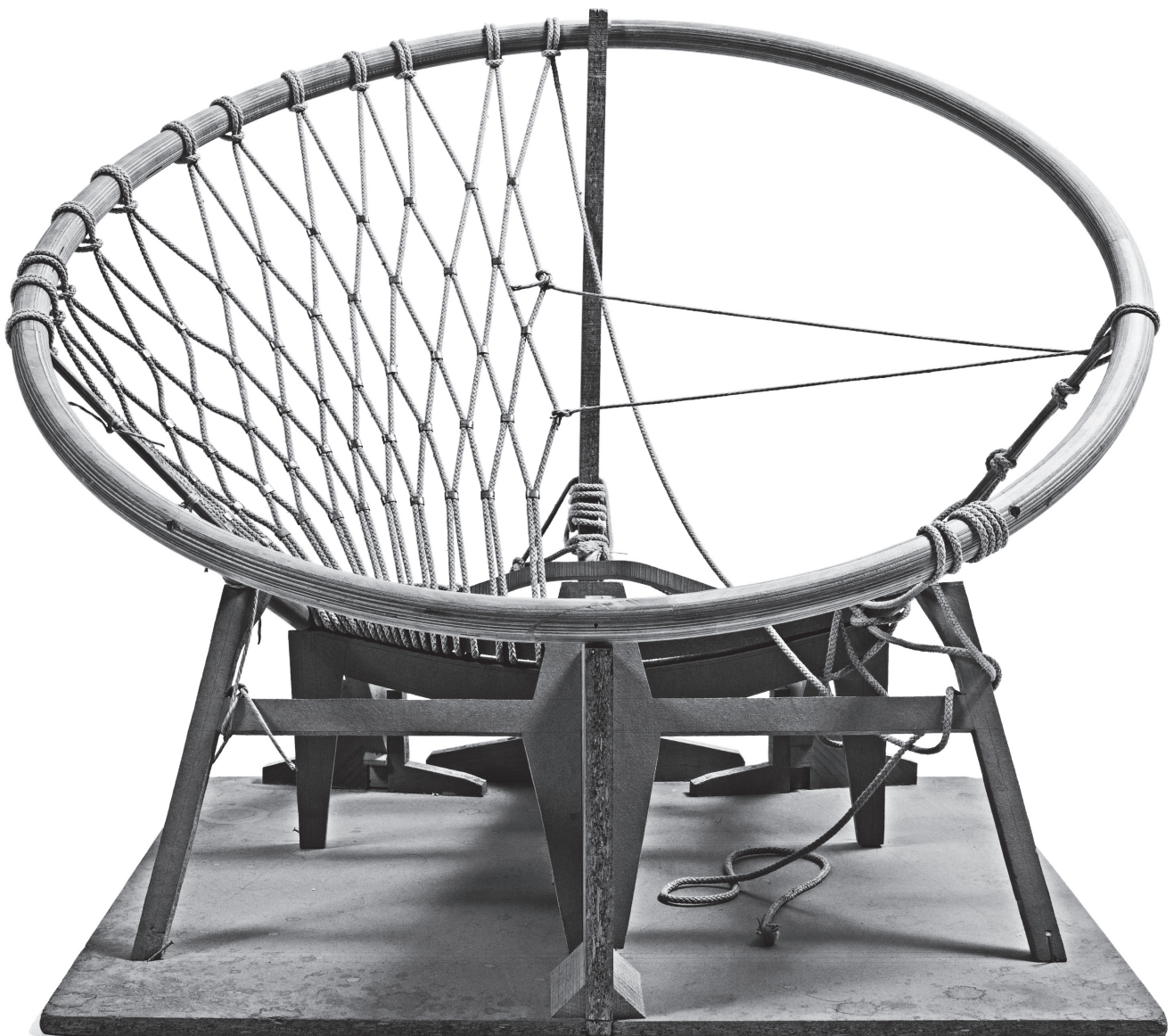

Laminating

Laminating is possible because wood is flexible and thin pieces are easily bent. It is the technique of slicing up wood into thin pieces and gluing them together to form a new shape.

This is not as easy as it appears and is a relatively recent invention developed during WWII for the aircraft industry. In producing the Circle Chair we have developed laminating techniques far beyond those that are in industrial use.

The objective was simple. To produce a laminated ring from eleven layers of wood, each 3½ metres long and complete a full circular bend joining them end to end.

The execution was a huge challenge. Not only to accurately place all eleven layers into a mould but also to cut each layer precisely to the length required at a given circumference throughout the thickness of the ring.

Wegner himself thought the problem insurmountable and although he conceived the idea of the **Circle Chair** in 1965 it was not completed until 1986 in collaboration with PP Møbler.

The machine made to solve the problem of producing the large ring for the **Circle Chair** was designed and built by Søren Holst Pedersen.

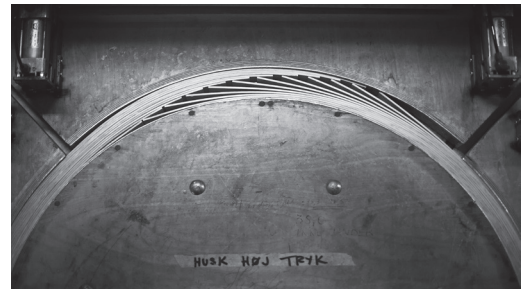

Circle Chair

Design: Hans J. Wegner, 1986

pp130

pp130 comes with wheels mounted on the back legs. The wheels and the clips connecting the flag halyard come in stainless steel, brass or black.

The flag halyard is available in nature or black. Flag line is made from jute and has a high tensile nylon core for optimal strength covered by a protective sleeve of woven jute. In order to optimise rigidity the flag line is stretched before it is applied to the chair.

Seat and neck cushions come in fabric or leather.

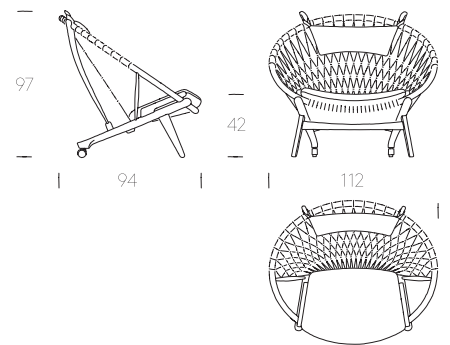

pp møbler

Vestvej 45
3450 Allerød
Denmark

info@pp.dk
www.pp.dk

