

Stayed Table

Design: Hans J. Wegner, 1982

pp75

ENQUIRIES
info@contextgallery.com
Tel. 404. 477. 3301
Tel. 800. 886.0867
contextgallery.com



Constructional masterpiece

This table is nothing short of a constructional masterpiece. Wanting to maximise the knee and legroom of those sitting at the table, Wegner joined the table legs in the centre and supported the table top with stays.

The combination of legs and stays turn into triangular formations constituting complete stability and tensile strength.

The construction is so sophisticated that the round top seems to balance on a centre point and so strong that despite its daring elegance, it even offers the possibility of extension by separating the two halves of the table top.

As is common in the best of Wegner's works, this table combines practicality with the most refined sense of aesthetics.



Stayed Table

Design: Hans J. Wegner, 1982

pp75 is available in two standard sizes: 120 cm and 140 cm and is available with a split top with extensions or with a one piece top.

We always fit the leaves individually to each table, so any extra leaves must be ordered with the table. Solid wood leaves and main tabletops are made of wood from the same tree.

The leaves for pp75 comes in solid or veneered. Please note that a veneered leaf will never match the grain and colour nuance of the solid wood table top.

All metal parts are stainless steel.

pp75

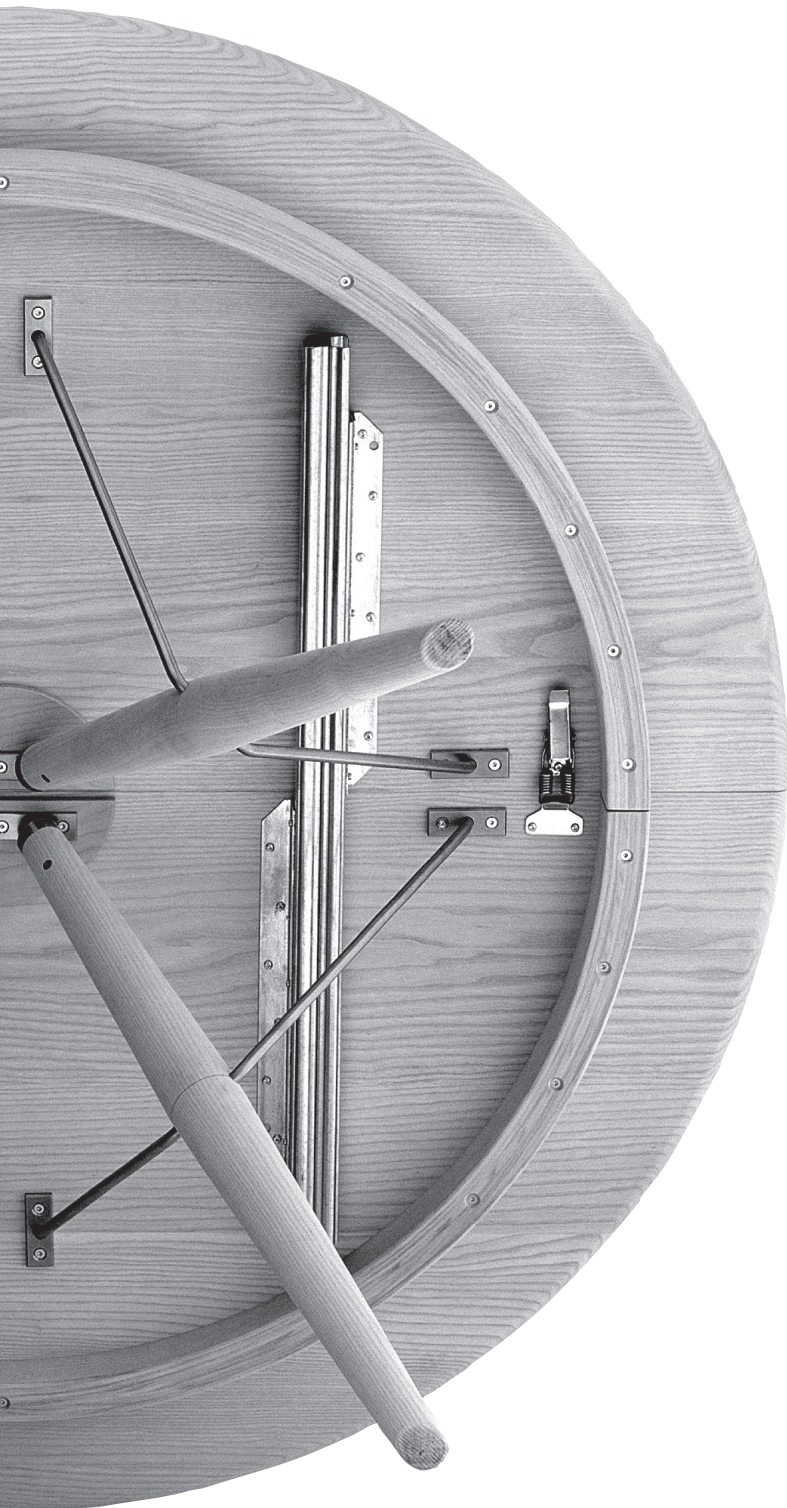

pp75/120

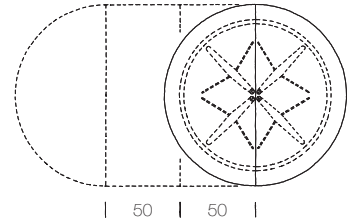
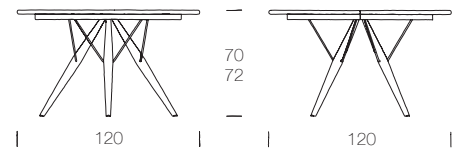

pp75/140

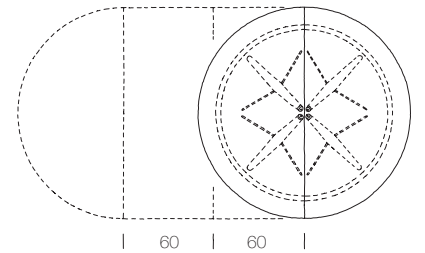
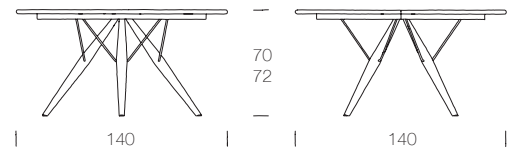

pp75/120

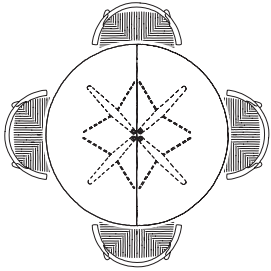

pp75/120
+ 4 pcs. pp68

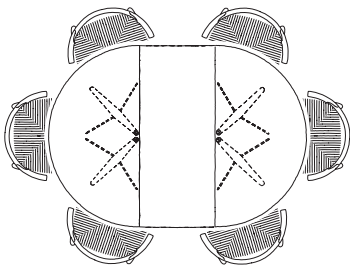

pp75/120
- with one leaf
+ 6 pcs. pp68

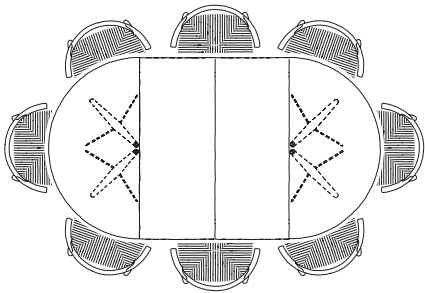

pp75/120
- with two leaves
+ 8 pcs. pp68

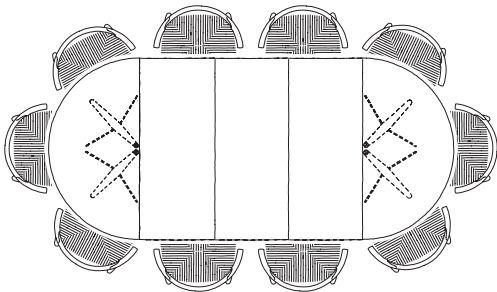

pp75/120
+ 10 pcs. pp68

Stayed Table

Design: Hans J. Wegner, 1982

pp75/140

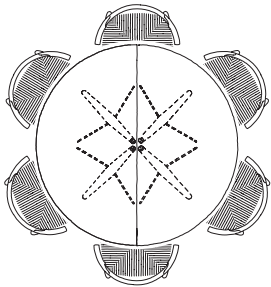

pp75/140
+ 6 pcs. pp68

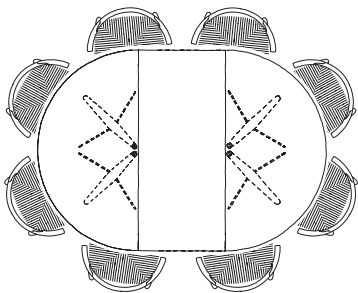

pp75/140
- with one leaf
+ 8 pcs. pp68

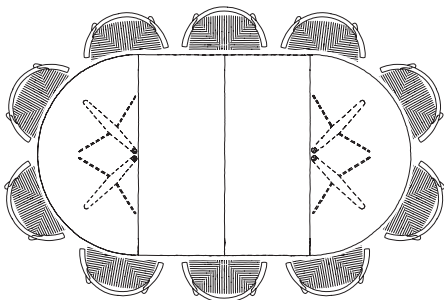

pp75/140
- with two leaves
+ 10 pcs. pp68

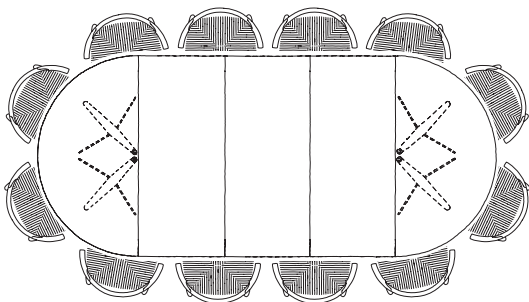

pp75/140
+ 12 pcs. pp68

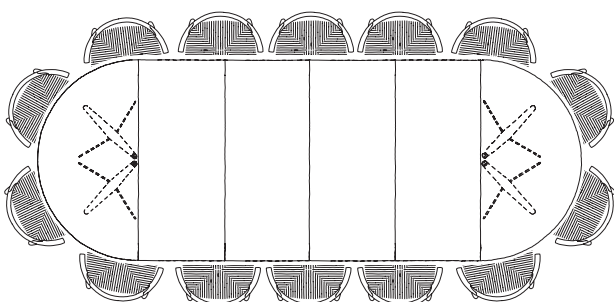

pp75/140
+ 14 pcs. pp68

Composing a table top

Every solid wood table from PP Møbler is made using the wood from a single tree. Each tree is cut, dried, machined into planks and then separated from the others. Planks are then cut into sections as wide as possible in order to minimise the number of joints and glue used in a finished tabletop.

This policy of only using the wood from a single tree to make the top is the best way to ensure a balanced hue across the surface and express the beauty of the wood so it gains an even patina over time. This attention to detail is important and adds to the future value of the table.

Because we select the individual pieces of wood that will make each tabletop we face a number of natural and inevitable conditions with which we are obliged to work. Normally we can produce between 1-4 tables per tree depending on its size and the dimensions of the table we are making.

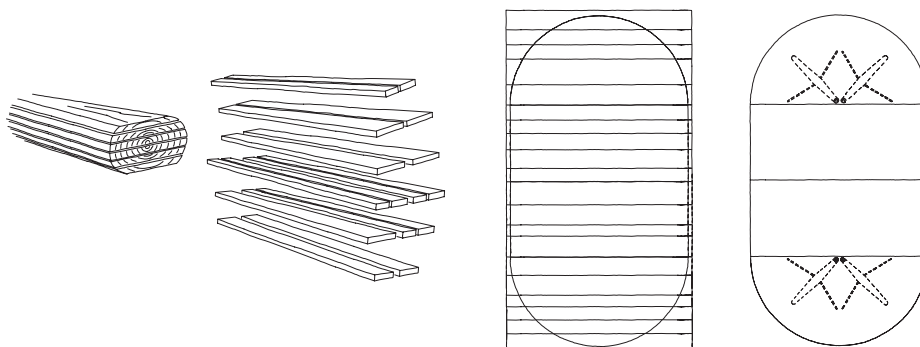

Stayed Table

Design: Hans J. Wegner, 1982

pp75



The composition of each tabletop is always thoughtfully considered and planned in detail. Every section is carefully evaluated from what a tree offers and they are glued together in the exact order selected by the individual craftsman for a particular top.

The same procedure applies to split tabletops including any solid leaves. For this reason it is important when ordering for example, a **pp75/140** with two solid wood leaves, that all of the wood for the top and the leaves are cut from the same tree. Finding the right tree for such a table is a considerable challenge.

The planks cut near the centre of the log are described as quarter cut and the planks cut away from the centre are known as being plain cut. Most wood types have medullary rays through which nutrients circulate that are a natural part of the trees biology.

Particularly in oak, the medullary rays are visible in the quarter cut planks and this is part of the strong character of the species. Any tabletop made of oak is likely to have visible medullary rays.

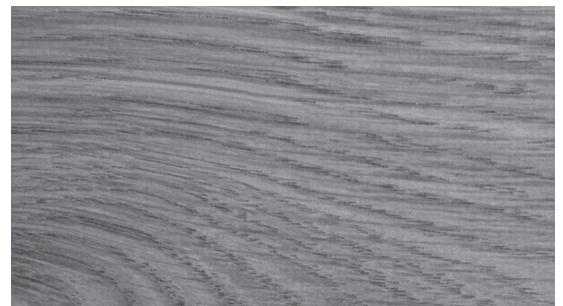
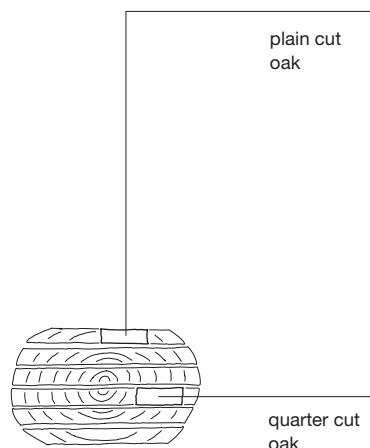

pp møbler

Vestvej 45
3450 Allerød
Denmark

info@pp.dk
www.pp.dk

